

Instinctive Print Solutions

Outdoor Collection

Quality products for high visual impact.

Weatherproof, robust and simple to use.

*Exhibition * Events * Signage * Display*

e-Innovation Centre, Priorslee, Telford, TF2 9FT

T: 0800 046 9899 **E:** sales@kyoti.co.uk **W:** kyoti-graphics.co.uk

Outdoor Inspiration

Welcome to the Outdoor Brochure, an impressive collection of display solutions - perfectly suited to both indoor and outdoor events. Whether you're looking to promote a sporting event, country show, trade fair or retail display, you'll find all you need to ensure a successful outdoor season! With a broad selection of simple to use products including large format banners, pavement signs, portable flags, sign holders and much more. Extremely robust and weatherproof, these stylish display systems are sure to tick all the boxes and create high-impact promotions for your business!

Contents

Flags	3
Banners	14
Sign Boards	20
Pedestrian Guidance	24
Counters and Tents	26
Beaufort Scale	29
Index	30



Product diagrams show
overall hardware size

Flags

There's no better way to get your message across and attract people into your space, than with outdoor flags. Stylish in design, these robust solutions are perfect for year-round promotions. Suitable for use in supermarkets, forecourts, music festivals, shopping centres and much more...



Wind Dancer

Portable and lightweight with eyelet fixings for graphics (Beaufort Scale 4)

Did you know?

The Wind Dancer is one of the biggest flags available – giving you up to 5M of great exposure!

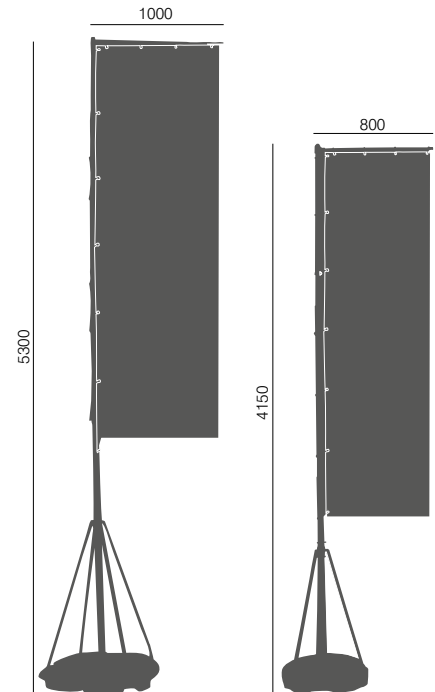

Wind Dancer 5m

WD105B Base
WD105P Pole

Graphic area (approx):
3500 (h) x 1000 (w) mm

Wind Dancer 4m

WD104B Base
WD104P Pole

Graphic area (approx):
2800 (h) x 800 (w) mm



Top tip!
 Popular and flexible flag option with a wide choice of bases. Available in four different shapes – Feather, Crest, Edge and Quill.

Crest	Graphic area (approx):
2.8m	1900 (h) x 500 (w) mm
3.4m	2600 (h) x 600 (w) mm
4.5m	3400 (h) x 785 (w) mm
5.6m	3900 (h) x 850 (w) mm

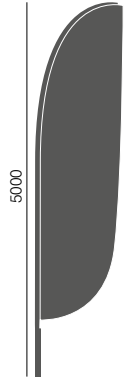
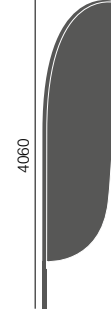
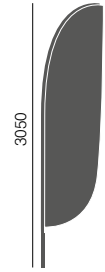
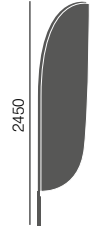

Zoom Lite - Crest

Perfectly placed outside fuel stations (Beaufort Scale 4)

Please note, the sizes displayed relate to the overall Flap size, including pole.



Feather	Graphic area (approx):
2.8m	2000 (h) x 550 (w) mm
3.4m	2600 (h) x 600 (w) mm
4.5m	3400 (h) x 796 (w) mm
5.6m	3900 (h) x 850 (w) mm

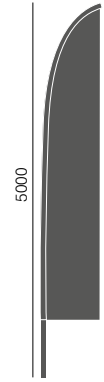
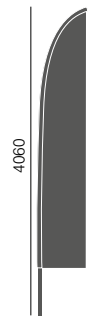
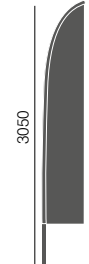
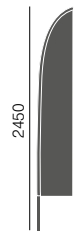

Zoom Lite - Feather

Ideal for promotions in shopping centres (Beaufort Scale 4)



Did you know?

Flags are an impressive and eye-catching way of promoting your message or product!

Quill	Graphic area (approx):
2.8m	1530 (h) x 680 (w) mm
3.4m	2058 (h) x 990 (w) mm
4.5m	2900 (h) x 1200 (w) mm
5.6m	3600 (h) x 1204 (w) mm

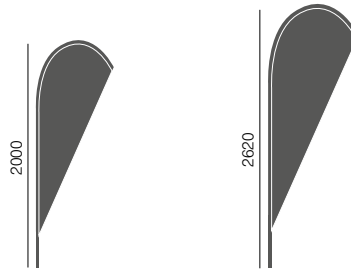

Zoom Lite - Quill

Stylish design, suitable for use outside health clubs (Beaufort Scale 4)

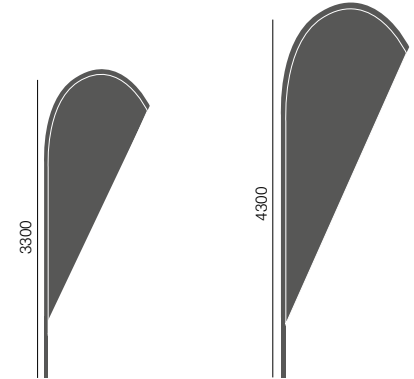

Turn overleaf to order the corresponding poles and bases for each Flag.

Egde	Graphic area (approx):
UF-ZME2	1.3m 1300 (h) x 785 (w) mm
UF-ZME3	2.3m 2300 (h) x 785 (w) mm
UF-ZME4	3.3m 3300 (h) x 785 (w) mm
UF-ZME5	4.3m 4300 (h) x 785 (w) mm

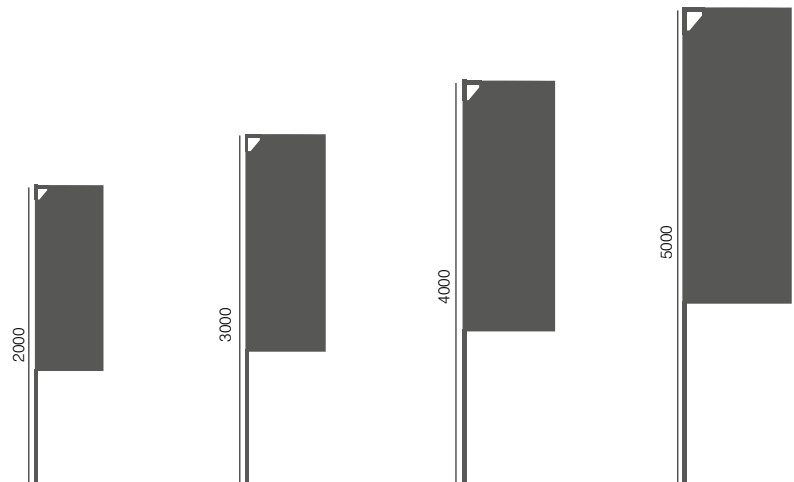

Zoom Lite - Edge

Make your message stand out from the crowd

Zoom Lite Bases, explained:

If you're unsure about which base will work best for your flag size and shape, then read the guide below for more detail.

1. Large Cross Base

Suitable for use on even, hard surfaces with 2.8m, 3.4m, 4.5m and 5.6m flags.

2. Square Base

Suitable for use on even surfaces with 2.8m, 3.4m, 4.5m and 5.6m flags.

3. Weighting Ring

Capacity approx. 6 litres. Promotes stability when using Small Cross Base, Large Cross Base and Square Base.

4. Ground Spike

Suitable for use on medium soft ground, including grass. Use with 2.8m, 3.4m, 4.5m and 5.6m flags.

5. Drive-on- Car Foot

Simply weigh your flag down using your very own vehicle.

6. Concrete Base

Suitable for use with 2.8m and 3.4m flags (weight: 22kg)

7. Small Cross Base

Suitable for use on even, hard surfaces with 2.8m and 3.4m flags.

8. Plastic Ground Stake

Suitable for use on soft ground, including sand. Use with 2.8m, 3.4m, 4.5m and 5.6m flags.

9. Outdoor Water Base

Capacity 26 litres, suitable for use with 2.8m and 3.4m flags.

10. Wall Mounting Base

Perfect for securing your flag to a wall surface. Suitable for use with 2.8m and 3.4m flags.

11. Outdoor Water Base with Feet

Capacity 21 litres, can be pegged down. Suitable for use with 2.8m, 3.4m, 4.5m and 5.6m flags.

Zoom Lite base options

Choose from the wide selection of bases suitable for use with the Zoom Lite range.

Pole Length for Quill, Feather, Crest

2.8m	3.4m	4.5m	5.6m
UF-ZM28	UF-ZM34	UF-ZM45	UF-ZM56



Large cross base
UF-ZMLCB

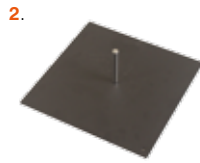

Square base
UF-ZMLSQ



Weighting ring
UB719-C



Ground spike
UF-ZMGS



Drive-on car foot
UF-ZMCF5



Concrete base
UF-ZMCEM



Cross base
UF-ZMSCB



Ground stake
UF-ZMPSS



Outdoor water base
UF-ZMGMB



Wall mounting base
UF-ZMWMF



Water base with feet
UF-ZMRMB

Optional carry bags:

2.8/3.4m AB-ZMS

4.8/5.6m AB-ZML

Base bag AB108

Top tip!

Can be used indoor or outdoor!
Perfect for year-round promotions!

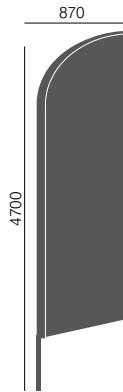
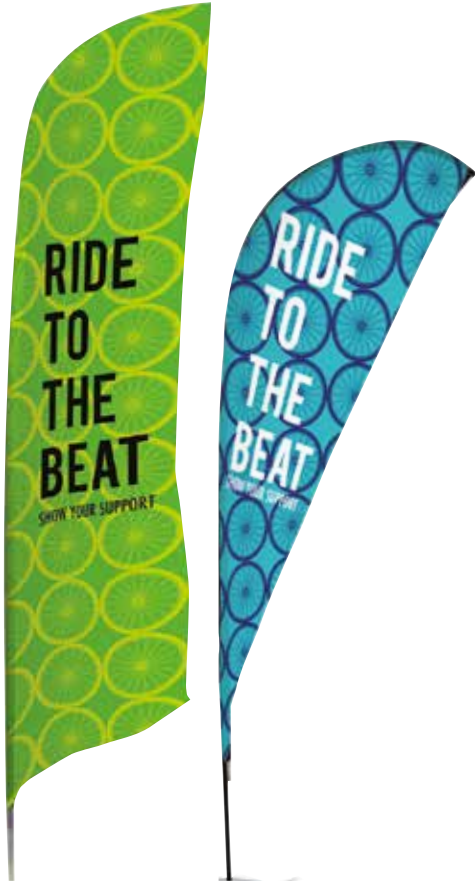

Feather 4.7m

UB724-C

Graphic area (approx):
4025 (h) x 870 (w) mm

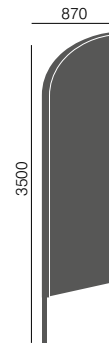

Feather 3.5m

UB724-01

Graphic area (approx):
3025 (h) x 870 (w) mm

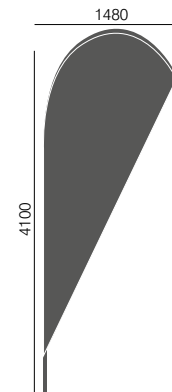

Quill 4.1m

UB717-C

Graphic area (approx):
3575 (h) x 1480 (w) mm

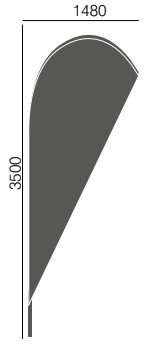

Quill 3.5m

UB717-01

Graphic area (approx):
3108 (h) x 1480 (w) mm



Base foot (includes bag)
UB718-C
Recommend use of weighting
ring with this base.



Weighting ring
UB719-C
(Sold separately - includes bag)



Ground spike
UB720-C



Drive-on car foot
UB721-C
(Bag not included)



Concrete case
UF-ZMCEM
Concrete base not suitable
for larger Feather shape.



Female fitting
UF-ZM003
(Optional extra)
Required for use with
concrete base.

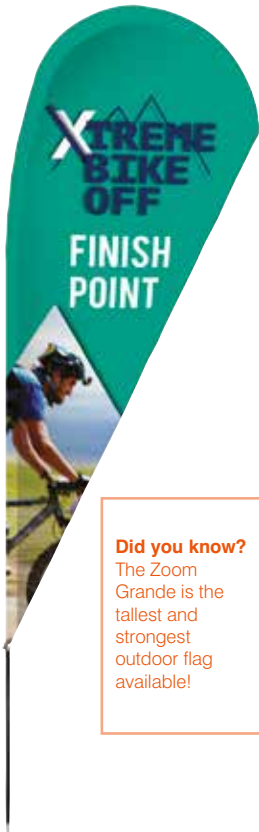

Did you know?
The Zoom Grande is the tallest and strongest outdoor flag available!



Feather
UB730-C

Graphic area (approx):
4600 (h) x 1050 (w) mm

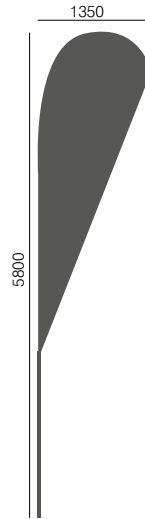

Quill
UB730-C

Graphic area (approx):
4502 (h) x 1400 (w) mm

Zoom Grande

Impressive flag, great for promoting your message from afar (Beaufort Scale 4)



Weighting ring
UB719-C



Square base
UB728-C

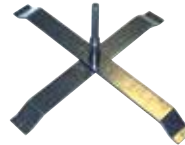

Cross base
UB727-C



Ground spike
UB731-C

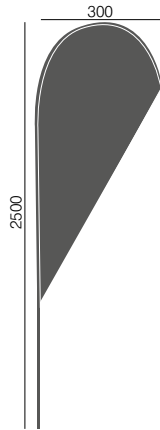

Mini Zoom 2.5m
UB726-C

Graphic area (approx):
2148 (h) x 1169 (w) mm

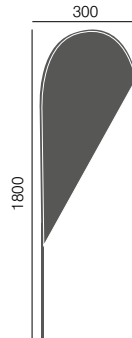

Mini Zoom 1.8m
UB726-C

Graphic area (approx):
1800 (h) x 842 (w) mm

Mini Zoom

With glass fibre pole, usable at 1.8m or 2.5m (Beaufort Scale 4)

Top tip!
Ideal for use in areas where height may be restricted.



Ground spike
UB726-GS

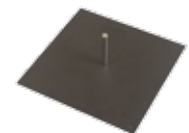

Square base
UB726-B



Top tip!
 Ideal for promoting outdoor events or for use at country parks and golf courses with lakes and reservoirs.



Counter weight and anchor

Zoom Aqua Flag Kit

With anchor and tether rope to enable use in water
 (For use in rivers, ponds and lakes with min depth of 1.2m and max 3.4m)

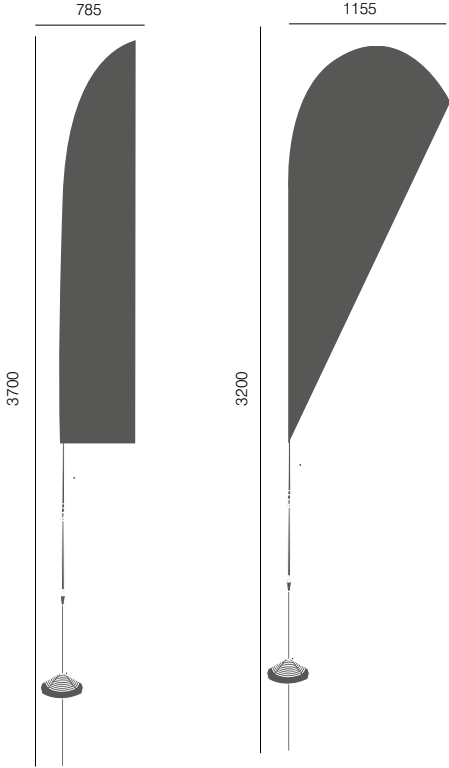

Feather
 UB116

Quill
 UB116

Graphic area (approx):
 2600 (h) x 600(w) mm

Graphic area (approx):
 3200 (h) x 1155 (w) mm



Top tip!
The Formulate Storm range is ideal for promoting outdoor sporting events!

Formulate Storm

Strong and durable aluminium tube flag poles
(Beaufort Scale 4)

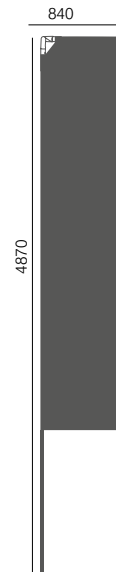

Storm 90 4.8m

UB732 -C

Graphic area (approx):

3600 (h) x 840 (w) mm



Storm 90 3.6m

UB732 -C

Graphic area (approx):

2400 (h) x 840 (w) mm

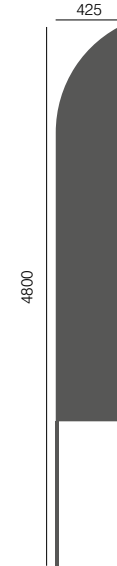

Storm Curve 4.8m

UB733 -C

Graphic area (approx):

3600 (h) x 425 (w) mm

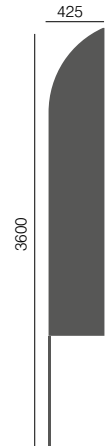

Storm Curve 3.6m

UB733 -C

Graphic area (approx):

2400 (h) x 425 (w) mm

Formulate Storm base options

Choose the best base option for your needs. Weighting ring recommended for use with large cross and square bases.



Large cross base*
UF-ZMLCB

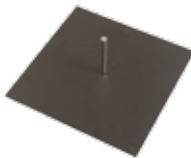

Square base
UF-ZMLSQ



Weighting ring
UB719-C



Ground spike*
UF-ZMGS



Drive-on car foot
UF-ZMCF5



Concrete base
UF-ZMCEM

Did you know?

The Double Sided Mistral can also be used on central reservations, allowing you to capture two-way traffic.

Mistral

Made using weatherproof aluminium castings and GRP tubes (Beaufort Scale 7)



Mistral

UB725

Graphic area (approx):

2000 (h) x 800 (w) mm

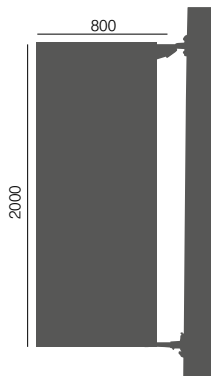

Rotating Mistral

Mount to posts or walls with extended arm, allowing the graphic to rotate in the wind (Beaufort Scale 7)



Rotating Mistral

UB725-R

Graphic area (approx):

1500 (h) x 800 (w) mm

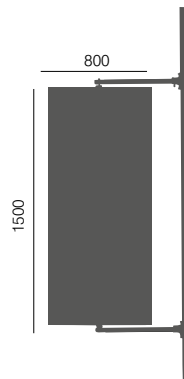

Double Sided Mistral

Designed to mount graphics onto lamp posts using both sides to display messages (Beaufort Scale 7)



Double Sided Mistral

UB725-D

Graphic area (approx):

2000 (h) x 800 (w) mm

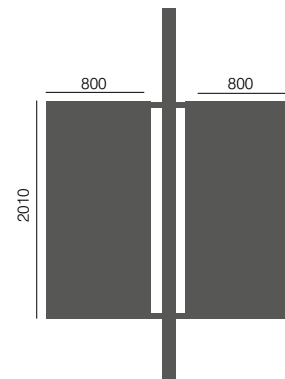

Shimmer

Outdoor/indoor flag pole with hollow base for sand or water weighting



Shimmer
WD102

Graphic area (approx):
1800 (h) x 550 (w) mm

Eco

Economy flag pole with easy plastic push-fit assembly

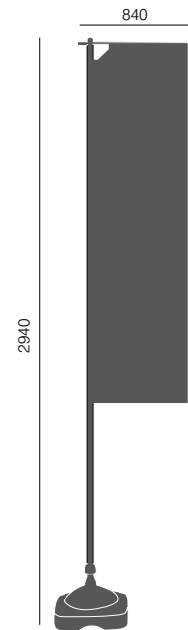

Eco
WD101B
WD101

Graphic area (approx):
1800 (h) x 550 (w) mm

Top tip!

Look after your flag system to ensure maximum longevity - see page 13 for caring instructions.

Caring for your flags:

To ensure maximum return on investment, it is essential to care for your flag in the right way. By following our step-by-step guide, you can be sure to maximise its use and extend the life of your flag.

- 1 /** Consider where you position your flag as air pollution will cause the white areas to become grey and UV can, over time, cause deterioration and fading to the fabric.
- 2 /** Life expectancy is entirely dependant on the climatic conditions and hours of flying. Realistic maximum lifespan of a flag used regularly is approx. six months. If any edges of the flag become frayed then trim, reinforce and re-hem to extend its life.
- 3 /** Dismantle your flag during adverse weather conditions, including strong winds over Beaufort Scale 6 (see page 29 for more information). Heavy rain combined with high winds can increase the weight of the flag and put extra strain onto the pole.
- 4 /** Flags can be washed in a regular washing machine on a 40° wash with everyday detergents. Always allow your flag to completely dry out before storing.
- 5 /** Ensure that your flag doesn't catch or snag on its pole or any other surrounding objects. Do not place poles too close together.

Banners

Behold the unbeatable banner – your trusted display solution! Practically suited to most environments, including in-store promotions, conferences and advertising, the banner is available in a variety of options, each one designed to accommodate your business needs. Lightweight and stylish in design, choose from a selection of roller, rigid, tension or cassette housing.



Did you know?

The Thunder banner is double-sided, allowing you to display your message on both sides, for maximum impact!

Easy to assemble and transport

Thunder

Roller banner, with twin feet, snap rail and three-part bungee pole (Beaufort Scale 2 free-standing, 5 if pegged down)

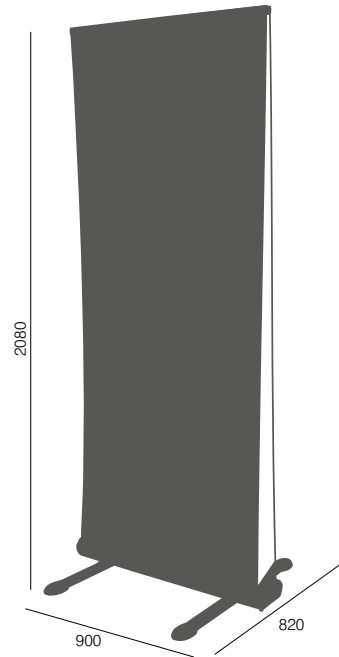

Thunder 850mm (w)

UB185-850

Graphic area (approx):

2025 (h) X 850 (w) mm



“Gives you a portable display – outdoor or indoor!”

Hurricane

Single or double-sided tension banner, weather resistant (Beaufort Scale 4)

With spring loaded poles for extra wind resistance

Top tip!

If you're looking for the perfect banner for outdoor retail displays and event promotions, then the stylish and durable Hurricane banner is for you!

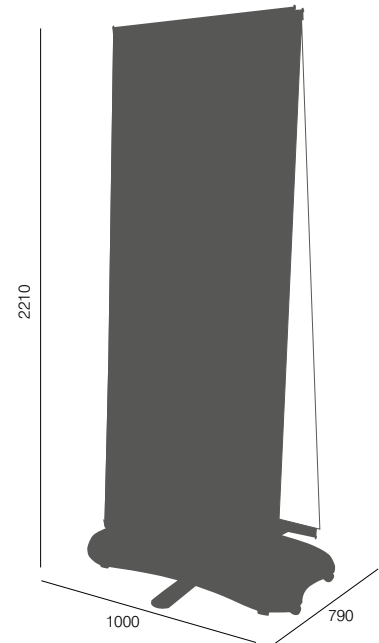

Hurricane

UB700

Graphic area (approx):

1950 (h) x 800 (w) mm



Did you know?
This banner is super versatile as it allows you to accommodate different graphic sizes to suit your needs!

Blizzard

Tension banner with adjustable telescopic pole and hollow plastic base for water or sand weighting (Beaufort Scale 4)

“Durable outdoor banner stand”



Get your message across with 2M of great exposure!

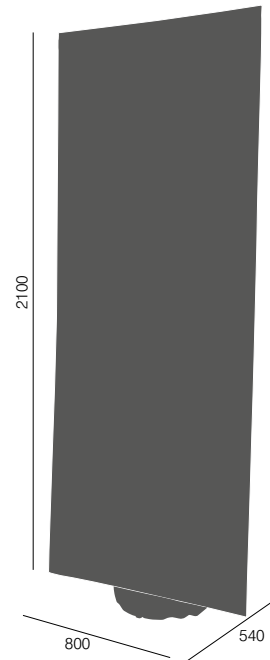

Blizzard 800mm (w)

UB701-C

Graphic area (approx):

2000 (h) x 800 (w) mm



Top tip!

Perfect display solution, available double-sided for reaching two-way traffic!

“Durable double-sided outdoor banner stand”

Can be weighted down using water or sand

Storm Hydro 2

Single or double-sided weather-resistant banner (Beaufort Scale 3)

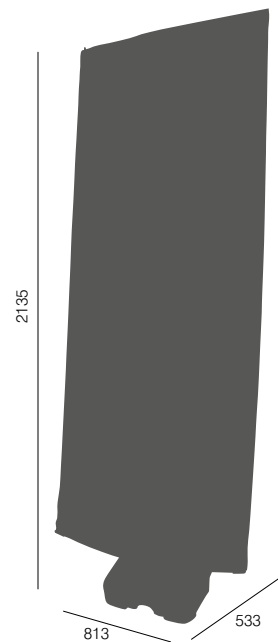

Storm Hydro 2 800mm (w)

UB209

Graphic area (approx):

1800 (h) x 800 (w) mm



“the 5 second banner”

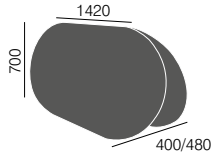

Stowaway 1400 mm

UB736-03

Graphic area (approx):

650 (h) x 1354 (w) mm

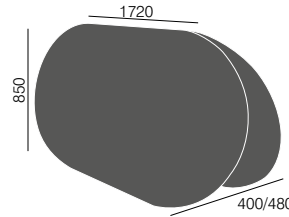

Stowaway 1700mm

UB736-02

Graphic area (approx):

820 (h) x 1650 (w) mm

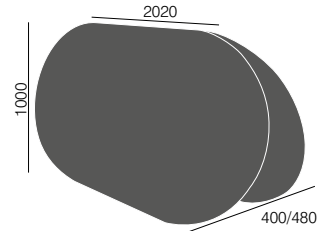

Stowaway 2000mm

UB736-01

Graphic area (approx):

990 (h) x 1962.5 (w) mm

Stowaway

Extremely portable and lightweight in design, supplied with carry bag and ground pegs

Horizon

Single or double-sided banner system with hollow feet for sand or water weighting (Beaufort Scale 3)

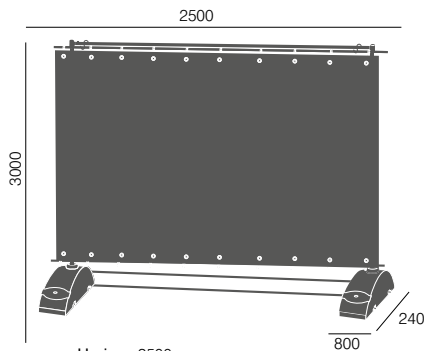

Horizon 2500 mm

UB203

Graphic area (approx):

2000 (h) x 2500 (w) mm

Did you know?

The Horizon banner is one of the widest available – ideal for large outdoor events, such as air and motor shows.





Top tip!

Ideal for outdoor windy events as they can be pegged down!

Monsoon and Mini Monsoon

Double sided A-frame banners suitable for indoor or outdoor use (Beaufort Scale 5)

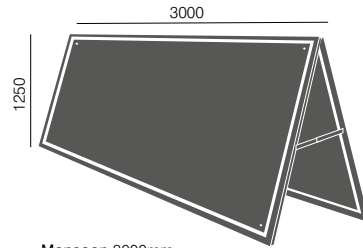

Monsoon 3000mm

UB711-C

Graphic area (approx):
1090 (h) x 2840 (w) mm

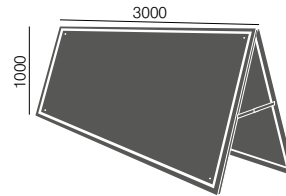

Monsoon 2500mm

UB707-C

Graphic area (approx):
840 (h) x 2340 (w) mm

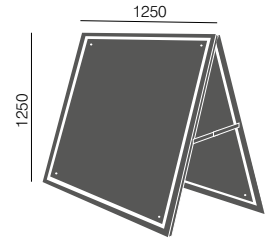

Mini Monsoon 1250mm

UB708-C

Graphic area (approx):
1090 (h) x 1090 (w) mm

Wall Monsoon

Wall mounted banner, perfectly suitable for roadside or field advertising

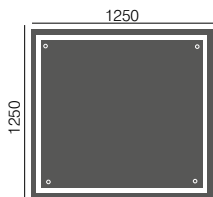

Wall Monsoon 1250mm

UB712

Graphic area (approx):
840 (h) x 840 (w) mm



Wall Monsoon 2000mm

UB713

Graphic area (approx):
840 (h) x 1840 (w) mm

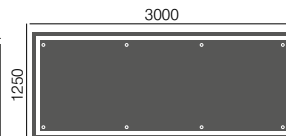

Monsoon 3000mm

UB714

Graphic area (approx):
1090 (h) x 2840 (w) mm



Sign Boards

Not just a sign board, but also an essential item to boost your marketing campaign! With swing signs, A-signs, rigid signs and much more, you'll find all you need to help your business. Allowing for quick graphic changes, these systems are ideal for when you need to vary your message regularly.



Liquid Chalk Board

Ideal pavement sign and menu board, perfectly placed in retail and catering environments



Liquid chalk Pens

Pack of 4 coloured liquid chalk pens, approx. 4mm tip



Top tip!

Pavement advertisers can be used indoor or outdoor – perfect for theatres and entertainment venues!

A-Sign Board

Double-sided snap frame available in A1 and A2 sizes

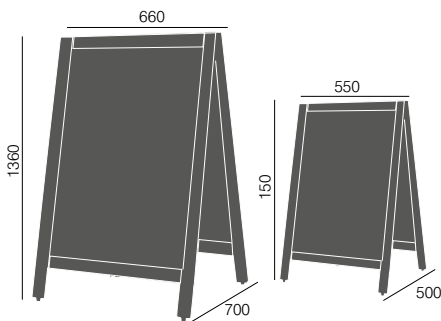

Woodern A Board - Large

VF201-01

Graphic area (approx):

1000 (h) x 570 (w) mm

Woodern A Board - Medium

VF201

Graphic area (approx):

670 (h) x 470 (w) mm



Liquid chalk Pens

VF201-P

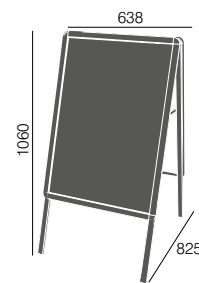

A Sign Board A1

VF204-C

Graphic area (approx):

831 (h) x 584 (w) mm

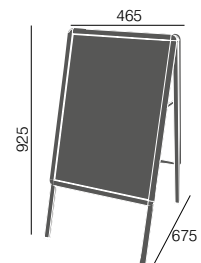

A Sign Board A2

VF204-A2

Graphic area (approx):

594 (h) x 420 (w) mm



Did you know?
 You can print your message onto the pre-stamped aluminum sheet using self-adhesive transfers or UV flat bed print.

Shield

Rigid sign board with hard recycled rubber base and securing bolts

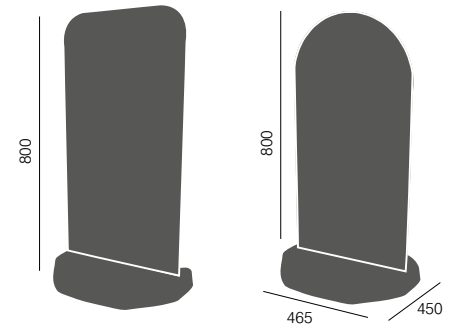

Shield Curved

UB108

Shield Arched

UB109
 Arched

UB108B
 base only

Graphic area (approx):

800 (h) x 410 (w) x 1.2 (d) mm



Whirlwind

Heavy-duty swing sign, ideal for pavement advertising

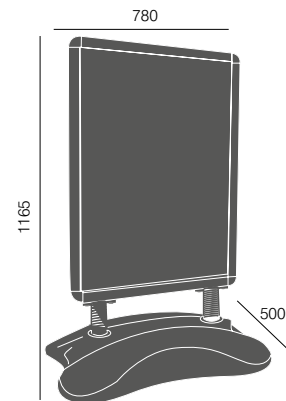

Whirlwind A1

UB207

Graphic area (approx):

820 (h) x 575 (w) mm



Rok

Supports rigid graphic panels in a variety of substrates

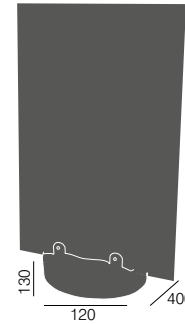

Rok

UB104

Graphic area (approx):

Foamcore 900 (h) x 600 (w) mm

MDF 1200 (h) x 800 (w) mm



Top tip!

Easy to use cost-effective and durable sign boards are ideal for use in car parks, shopping centres and outside shops.

Sign Board Lite

Large graphic area ideal for self adhesive or cut vinyl graphics

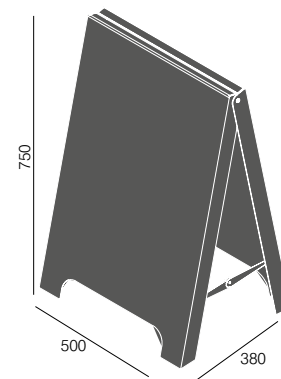

Sign Board Lite

VF205

Graphic area (approx):

693 (h) x 486 (w) mm



Can be linked together using linking chain

Top tip!
The Trojan can be linked together to promote queue control – perfect for use outside restaurants or concerts!

Trojan

Freestanding, portable and linkable information unit

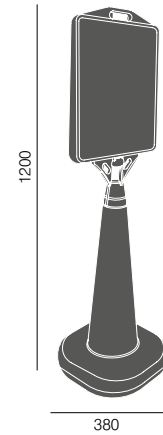

Trojan	Linking chain
SP-TRO	SP-TRO-LC

Graphic area (approx):
380 (h) x 330 (w) mm



Top tip!
Ideal for use on smooth surfaces, such as car roof promotions.

Limpit

Promoter unit with suction cup system, holds material up to 10mm thick

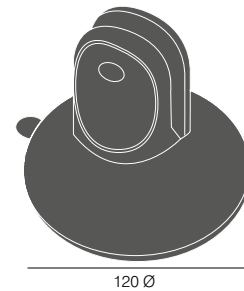

Limpit
SP-LIM

Graphic area (approx):
Variable

Pedestrian Guidance

Stylish yet functional, what you see is what you get – a proactive solution which defines areas outside restaurants, bars and clubs whilst also promoting your message! Designed to help with queue control, these versatile barriers come as a stand-alone or can be expanded to suit your needs!



Deluxe Café Barrier

Stylish and stainless steel heavyweight barrier, sold as individual components

Top tip!

Can be supplied with single or double-sided graphics.

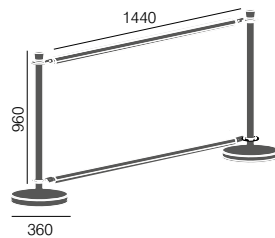

Deluxe Café Barrier 1000

UB215-1000

Graphic area (approx):

775 (h) x 850 (w) mm

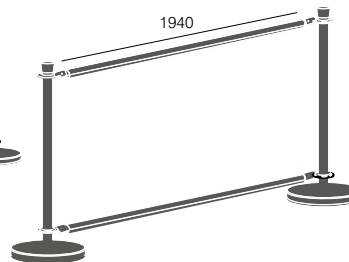

Deluxe Café Barrier 1500

UB215-1500

Graphic area (approx):

775 (h) x 1350 (w) mm

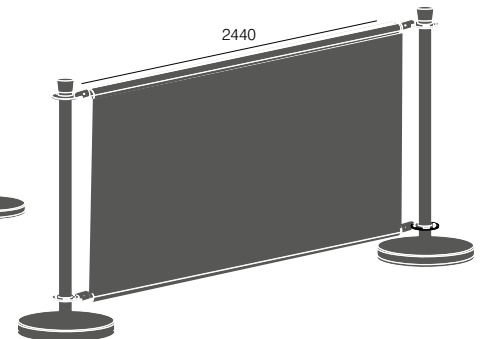

Deluxe Café Barrier 2000

UB215-2000

Graphic area (approx):

775 (h) x 1850 (w) mm

Items	Code
Post	UB215P
Base	UB215B

“Use it almost anywhere”



Economy Café Barrier

Cost effective barrier, sold as individual components

Top tip!
Barriers can be linked together to form a protective wall around your outdoor dining areas!

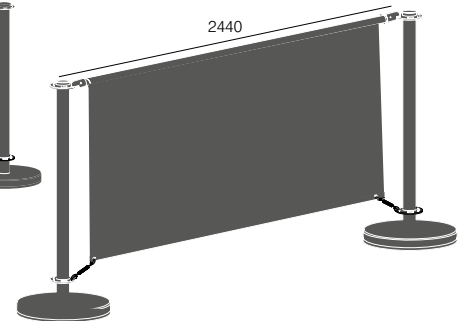
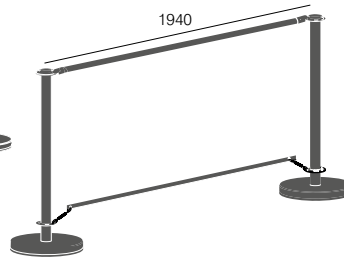
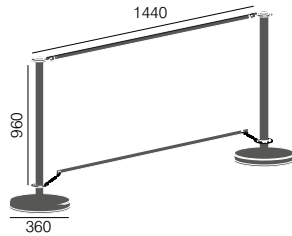

Items	Code
Post	UB214P
Base	UB214B
Spring Clips	UB214-SC

Economy Cafe Barrier 1000
UB214-1000
Graphic area (approx): 675 (h) x 850 (w) mm

Economy Cafe Barrier 1500
UB214-1500
Graphic area (approx): 675 (h) x 1350 (w) mm

Economy Cafe Barrier 2000
UB214-2000
Graphic area (approx): 675 (h) x 1850 (w) mm

Counters and Tents

If you're looking to promote your message in an outdoor environment then a tent kit may be just the ticket! Ideal for outdoor events, no matter the weather, they can be customized to meet your requirements. Complete the look with a stylish and practical counter (see page 28 for details) – perfect for welcoming clients into your space.

Available in a choice of 4 colours - Red, White, Black or Blue



Zoom Tent Kit

Quick and easy to assemble kit, includes frame and ground pegs (Beaufort Scale 5)

Top tip!

The optional sides can be printed in full colour.

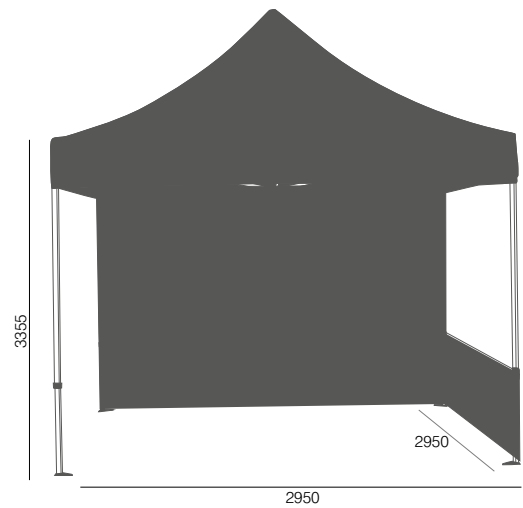

Zoom Tent Frame

ZT33-XAF

Graphic area (approx):

2100 (h) x 2790 (w) mm

Canopy optional



Optional full back wall





Top tip!

Ideal for indoor or outdoor use as a ticket booth or welcome counter.

Tornado

Able to endure all types of weather, with hollow base for water or sand weighting

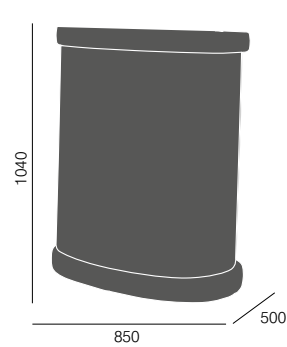

Tornado base

PK410

Graphic area (approx):

872 (h) x 950 (w) mm

PVC Wrap:

900 (h) x 2070 (w) mm

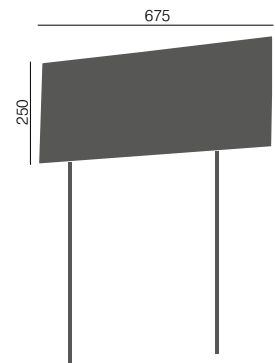

Tornado header

PK410

Graphic area (approx):

250 (h) x 675 (w) mm

Beaufort Scale

A wide variety of the Outdoor products have been tested to ascertain suitability during various weather conditions in the UK. The products themselves have been measured against variant wind speeds and categorised according to the Beaufort Scale - the imperial measure that relates wind speed to observed conditions on land and at sea.

Within most individual product descriptions you should find a Beaufort Scale reference. The measurements listed mean that you may use the product during wind speeds up to the maximum mph/knots specified.

Below you will find the Beaufort Scale table, displaying wind measurements and descriptions. It is advisable that you check the weather forecast regularly to determine if your product is suitable for outdoor use.

Please note that the measurements are 'mean speeds', meaning that they have been recorded as average figures over a 10-minute period and do not take into account sudden gusts of wind. Also, the measurements are taken 10m above ground, not at surface level. The following table should be used as a guide only and ultimately it is your responsibility to look after your display equipment.

Beaufort	Knots	MPH	Surroundings
0 Calm	Less than 1		Calm, smoke rises vertically
1 Light Air	1-3	1.2-3.0	Smoke drift indicates wind direction, still wind vanes
2 Light Breeze	4-6	3.7-7.5	Wind felt on face, leaves rustle, vanes begin to move
3 Gentle Breeze	7-10	8.0-12.5	Leaves and small twigs constantly moving, light flags extended
4 Moderate Breeze	11-16	13.0-18.6	Dust, leaves, and loose paper lifted, small tree branches move
5 Fresh Breeze	17-21	19.3-25.0	Small trees in leaf begin to sway
6 Strong Breeze	22-27	25.5-31.0	Larger tree branches moving, whistling in wires
7 Near Gale	28-33	32.0-38.0	Whole trees moving, resistance felt walking against wind

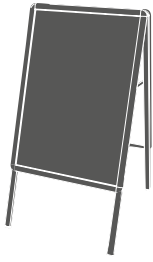

20

A-Sign Board



16

Blizzard



25

Deluxe Café Barrier



11

Double Sided Mistral



12

ECO



24

Economy Café Barrier



10

Formulate Storm 90



10

Formulate Storm Curve

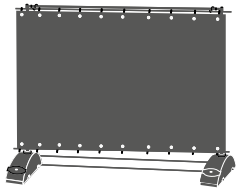

18

Horizon

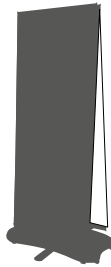

15

Hurricane

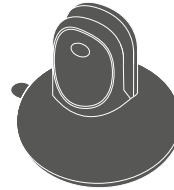

23

Limpit

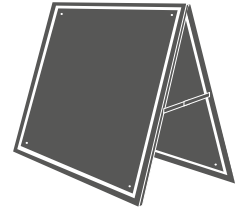

19

Mini Monsoon



8

Mini Zoom



11

Mistral

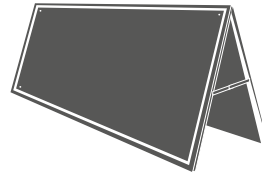

19

Monsoon

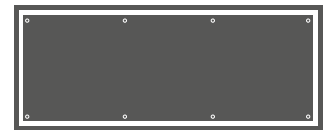

19

Monsoon Wall



22

Rok



11

Rotating Mistral

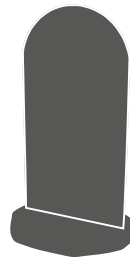

21

Shield



12

Shimmer

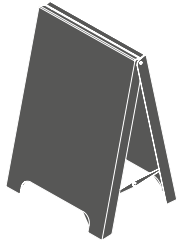

22
Sign Board Lite



17
Storm Hydro 2

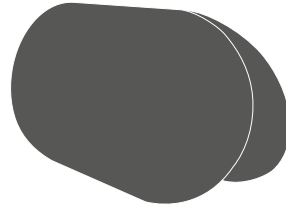

18
Stowaway

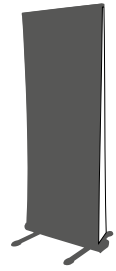

14
Thunder



28
Tornado



23
Trojan

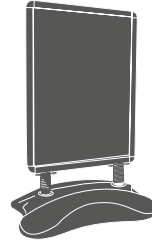

20
Whirlwind



3
Wind Dancer

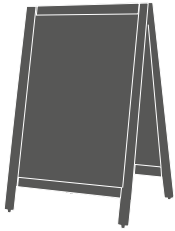

21
Liquid Chalk Board



9
Zoom Aqua Flag Feather



9
Zoom Aqua Flag Quill



6
Zoom Feather



7
Zoom Grande Feather



7
Zoom Grande Quill



5
Zoom Lite - Egde



4
Zoom Lite - Crest



4
Zoom Lite - Feather



5
Zoom Lite - Quill



6
Zoom Quill

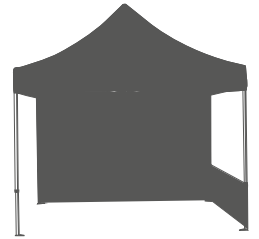

26
Zoom Tent Kit

OUTDOOR

Portable outdoor display solutions

Guarantee

All products are covered by a Manufacturers' Guarantee against component failure and defects. Our premium banner range is covered by a lifetime guarantee, the rest of our range is covered by a five year guarantee, with the exception of our, illuminated, 'Basics' and Outdoor products, which are covered by a one year guarantee.

We are continually improving and modifying our product range and reserve the right to vary the specifications without prior notice. All dimensions state height first and both dimensions and weights quoted are approximate.

We accept no responsibility for variance.
E&OE.